

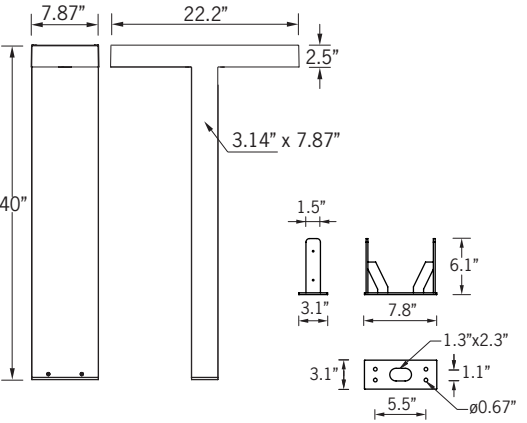

2x29w LED 2x3169 Lumens
IP65 • Suitable For Wet Locations
IK08 • Impact Resistant (Vandal Resistant)
Weight 32.8 lbs



Mounting Detail

Construction

Aluminum
Less than 0.1% copper content – Marine Grade 6060 extruded & LM6 Aluminum High Pressure die casting provides excellent mechanical strength, clean detailed product lines and excellent heat dissipation.

Pre paint
8 step degrease and phosphate process that includes deoxidizing and etching as well as a zinc and nickel phosphate process before product painting.

Memory Retentive -Silicon Gasket
Provided with special injection molded "fit for purpose" long life high temperature memory retentive silicon gaskets. Maintains the gaskets exact profile and seal over years of use and compression.

Thermal management
LM6 Aluminum is used for its excellent mechanical strength and thermal dissipation properties in low and high ambient temperatures. The superior thermal heat sink design by Ligman used in conjunction with the driver, controls thermals below critical temperature range to ensure maximum luminous flux output, as well as providing long LED service life and ensuring less than 10% lumen depreciation at 50,000 hours.

Surge Suppression
Standard 10kv surge suppressor provided with all fixtures.

BUG Rating
B1 - U0 - G1

Finishing
All Ligman products go through an extensive finishing process that includes fettling to improve paint adherence.

Paint
UV Stabilized 4.9Mil thick powder coat paint and baked at 200 Deg C. This process ensures that Ligman products can withstand harsh environments. Rated for use in natatoriums.

Inspired by Nature Finishes
The Inspired by nature Finishing is a unique system of decorative powder coating. Our metal decoration process can easily transform the appearance of metal or aluminum product into a wood grain finish.

This patented technology enables the simulation of wood grain, and even marble or granite finish through the use of decorative powder coating.

The wood grain finish is so realistic that it's almost undistinguishable from real wood, even from a close visual inspection. The system of coating permeates the entire thickness of the coat and as a result, the coating cannot be removed by normal rubbing, chipping, or scratching.

The Coating Process
After pre-treatment the prepared parts are powder coated with a specially formulated polyurethane powder. This powder provides protection against wear, abrasion, impact and corrosion and acts as the relief base color for the finalized metal decoration.

The component is then wrapped with a sheet of non-porous film with the selected decoration pattern printed on it using special high temperature inks.

This printed film transfer is vacuum-sealed to the surface for a complete thermo print and then transferred into a customized oven. The oven transfers the ink into different forms within the paint layer before it becomes solid. Finally, the film is removed, and a vivid timber look on aluminum remains.

Wood grain coating can create beautiful wood-looking products of any sort. There are over 300 combinations of designs currently in use. Wood grains can be made with different colors, designs, etc.

Our powder coatings are certified for indoor and outdoor applications and are backed by a comprehensive warranty. These coatings rise to the highest conceivable standard of performance excellence and design innovation.

- Added Benefits**
- Resistance to salt-acid room, accelerated aging
 - Boiling water, lime and condensed water resistant
 - Anti-Graffiti, Anti-Slip, Anti-Microbial, Anti-Scratch
 - Super durable (UV resistant)
 - TGIC free (non-toxic)

Hardware
Provided Hardware is Marine grade 316 Stainless steel.

Anti Seize Screw Holes
Tapped holes are infused with a special anti seize compound designed to prevent seizure of threaded connections, due to electrolysis from heat, corrosive atmospheres and moisture.

Crystal Clear Low Iron Glass Lens
Provided with tempered, impact resistant crystal clear low iron glass ensuring no green glass tinge.

Optics & LED
Precise optic design provides exceptional light control and precise distribution of light.
LED CRI > 80

Lumen - Maintenance Life
L80 /B10 at 50,000 hours (This means that at least 90% of the LED still achieve 80% of their original flux)

Area distribution bollard-integrated projectors. Stylish but technically precise area lighting solutions as part of a large flexible family.

Light Linear PT Bollard is an elegant minimalist bollard that is suitable for both modern and classic architecture. Ideal for creating visual guidance with exceptional visual comfort. The dual sealed optical chamber with integrated heat sinks houses a range of field interchangeable optically controlled LED's, providing Type II, III, IV & V distribution, as well as variations of this for precise light distribution requirements. An example of this, is using a combination of Type II and Type IV distribution optics inside the same fixture. This product range is available in 29w and 55w options, as single & double head styles.

Customer specific wattages can be provided, contact the factory for more information.

Bollards can be provided with GFCI boxes positioned to specific heights specified by the customer. Internal house side shields are available as an option.

To meet International Dark Sky criteria, 3000k or warmer LEDs must be selected.

Optional: Security Bollard:
The Light Linear Bollard is available as a traffic rated security bollard. This security bollard provides restraint of vehicular traffic in unauthorized areas. Impact calculations shows this bollard will stop a 5,500lb/2.75 tons vehicle, travelling at 30mph. The galvanized pole must be filled with concrete up to the waterproof driver housing to provide a solid concrete barrier.

Additional Options (Consult Factory For Pricing)

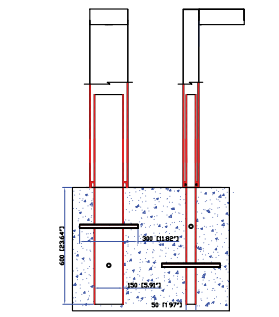

A13391 Security Bollard



GFCI CFCI Box



RCBW or Static Color Laser Cut Lettering, Logos & Designs (LLVT Bollard shown for visual reference)
Ligman can provide custom logos and signage in the Light Linear Bollard
The images above show this feature in the Light Linear VT Bollard

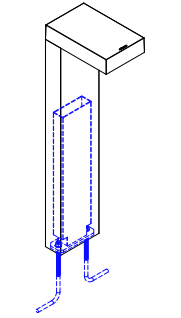

VRBI Vandal Resistant Bollard Insert
This vandal resistant galvanized steel insert provides additional support and rigidity in areas with high pedestrian traffic.



Ligman's micro Variable Optical System provides the ability to interchange, mix & rotate optics to provide specific light distributions for optimized spacing and uniformity.

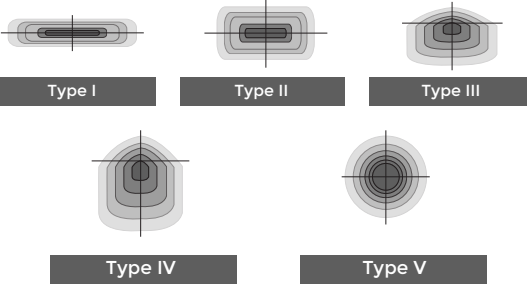

The variable optic system allows for the designer to create hybrid distributions for precise lighting requirements.

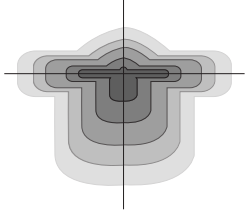

HYBRID TYPE I & TYPE IV

ULI-10031

Light Linear PT 2 Double Head Bollard



PROJECT	<input type="text"/>	DATE	<input type="text"/>
----------------	----------------------	-------------	----------------------

QUANTITY	<input type="text"/>	TYPE	<input type="text"/>	NOTE	<input type="text"/>
-----------------	----------------------	-------------	----------------------	-------------	----------------------

ORDERING EXAMPLE || ULI - 10031 - 2x29w - T2 - W30 - 02 - 120/277v - Options

ULI-10031	<input type="text"/>	<input type="text"/>	<input type="text"/>	<input type="text"/>	<input type="text"/>
------------------	----------------------	----------------------	----------------------	----------------------	----------------------

LAMP	BEAM	LED COLOR	FINISH COLOR	VOLTAGE
------	------	-----------	--------------	---------

2x29w LED
2x3169 Lumens

T1 - Type I Distribution
T2 - Type II Distribution
T3 - Type III Distribution
T4 - Type IV Distribution

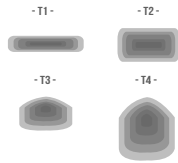

W27 - 2700K
W30 - 3000K
W35 - 3500K
W40 - 4000K

01 - BLACK RAL 9011
02 - DARK GREY RAL 7043
03 - WHITE RAL 9003
04 - METALLIC SILVER RAL 9006
05 - MATTE SILVER RAL 9006
06 - LIGMAN BRONZE
07 - CUSTOM RAL



120/277v
Other - Specify

<input type="text"/>	<input type="text"/>	<input type="text"/>
----------------------	----------------------	----------------------

ADDITIONAL OPTIONS

NAT - Natatorium Rated
F - Frosted Lens
HGT- Custom Bollard Height
DIM - 0-10v Dimming
AMB - Turtle Friendly Amber LED

HSS - House Side Shield
A13391 - Security Bollard
EMG - Emergency Pack
VRBI - Vandal Resistant Bollard Insert
GFCI - GFCI Box
[Standard location on back of bollard, consult factory for different location]

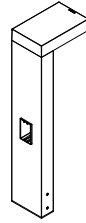

GFCI

INSPIRED BY NATURE FINISHES

SW01 - OAK FINISH
SW02 - WALNUT FINISH
SW03- PINE FINISH
DF - DOUGLAS FIR FINISH
CW - CHERRY WOOD FINISH
NW - NATIONAL WALNUT FINISH
SU01 - CONCRETE FINISH
SU02 - SOFTSCAPE FINISH
SU03 - STONE FINISH
SU04 - CORTEN FINISH

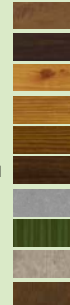

THERE IS AN ADDITIONAL COST FOR THESE FINISHES

LASER CUT LETTERING (Cannot be used in conjunction with security bollard)

RGBW - Color Changing RGBW
SC - Static Color (Choose Color e.g Red, Blue etc.)

WORDS FRONT	WORDS BACK
<input type="text"/>	<input type="text"/>

CONSULT FACTORY FOR CUSTOM DESIGNS, LOGOS AND OTHER SPECIAL REQUIREMENTS
FACTORY DRAWINGS WILL BE PROVIDED PRIOR TO PRODUCTION

More Custom Finishes Available Upon Request

Consult factory for pricing and lead times



Example: Inspired by Nature Finish



Light Linear PT Product Family



Light Linear PT 1

- ULI-10021-28w-3169lm
- ULI-10022-54w-6240lm



Light Linear PT 2

- ULI-10031-2x28w-2x3169lm
- ULI-10032-2x54w-2x6240lm



Light Linear PT 3

- ULI-21171-54w-6193lm
- ULI-21173-82w-8448lm



Light Linear PT 4

- ULI-21172-105w-12518lm
- ULI-21291-155w-16891lm



Light Linear PT 5

- ULI-21181-2x54w-2x6193lm
- ULI-21183-2x82w-2x8448lm



Light Linear PT 6

- ULI-21182-2x105w-2x12518lm
- ULI-21321-2x155w-2x16891lm



Light Linear PT 7

- ULI-21231-28w-3169lm



Light Linear PT 8

- ULI-21241-54w-6193lm

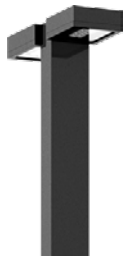

Light Linear PT 9

- ULI-21181-2x54w-2x6193lm
- ULI-21183-2x82w-2x8448lm

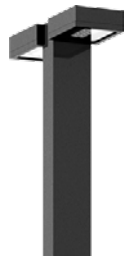

Light Linear PT 10

- ULI-21182-2x105w-2x12518lm
- ULI-21321-2x155w-2x16891lm



Light Linear PT 11

- ULI-30021-28w-3169lm
- ULI-30022-37w-4636lm



Light Linear PT 12

- ULI-30011-37w-4601lm
- ULI-30012-54w-6193lm

Light Linear PT-X



Light Linear PT-X 13

- ULI-21331-104w-15294lm
- ULI-21332-136w-19320lm

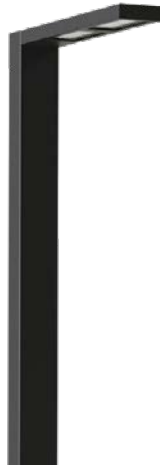

Light Linear PT-X 14

- ULI-21333-215w-30588lm
- ULI-21334-272w-38640lm

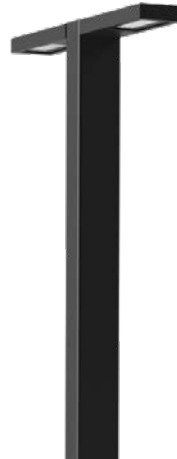

Light Linear PT-X 15

- ULI-21341-2x104w-2x15294lm
- ULI-21342-2x136w-2x19320lm

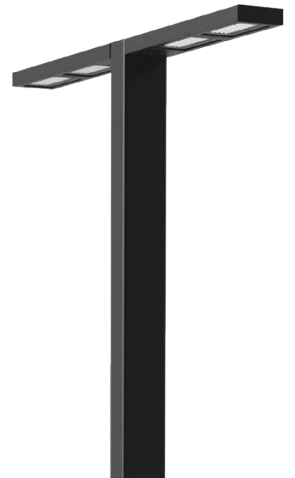

Light Linear PT-X 16

- ULI-21343-2x215w-2x30588lm
- ULI-21344-2x272w-2x38640lm